

Connected Dry-Contact

Cat. number : 4 121 73 - 1 991 23



Requires beforehand installation of a "with Netatmo" connected starter pack or a Control module (gateway).

Sommaire	Pages
1. Description - Use	1
2. Range.....	1
3. Overall dimensions.....	1
4. Preparation - Connection	2
5. General characteristics	6
6. Compliance and approvals	7
7. Equipment and accessories	7

1. DESCRIPTION - USE

Use:

. Allows single-phase measurement up to 80A and control in off-peak hours mode or in ON/OFF mode (real time or programmed) of electric vehicle terminals such as Green'up Premium or any other device equipped with a terminal block 12 VDC / 30VDC direct current control circuit (eg: heating manager, aeration/ventilation system, sprinkler system, etc.).

Can also control any type of circuit previously equipped with a power contactor (single-phase).

This product does not manage the "openings" appliances (roller shutters, gate).

Product compatible with the load shedding function (connected smart shedder Cat. number 4 121 72 - 1 991 20).

Technology:

. Monostable dry contact connected for control via smartphone, voice assistants and/or push button on the front panel.

Measurement of single-phase current up to 80A, by field effect using a closed toroid (delivered with the module) and sending data by radio frequency to the connected network.

Symbol:

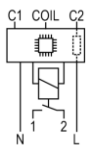

2. RANGE

Noise level:

. Noiseless switch: <10dB.

Width:

. 1 module. 17.8 mm wide.

Types of contact:

. Normally open contact type « F »

Rated current:

. 2 A

Rated voltage:

. 100 to 240V AC

Rated frequency:

. 50 / 60 Hz

Poles:

. 1 pole « 1F »

2. RANGE (continued)

Configuration and use:

Can be used with:

- Legrand smartphone app « HOME + CONTROL »

. Available for free on Google Play or App Store

- Voice assistants

- Connected Home Ecosystems



3. OVERALL DIMENSIONS

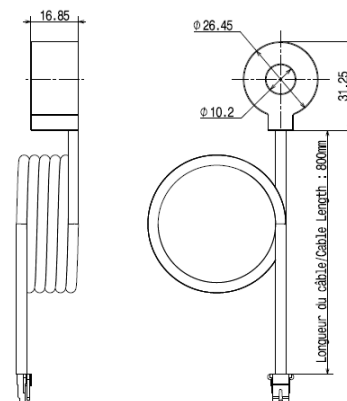
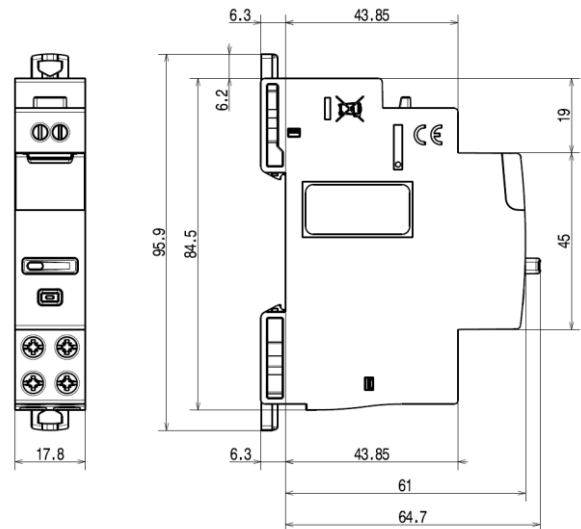

4. PREPARATION - CONNECTION

Mounting:

. On symmetrical rail EN / IEC 60715 or DIN 35.

Operating position:

. Vertical, Horizontal, Flat.



Row positioning:

. The product shape and the positioning of the terminals allow the passage of single-line, three-lines and plug-in supply busbars in the upper part of the product. Then, it is possible to freely choose the position of the Connected Dry-Contact in the row and to connect by supply busbar the other devices put on the same DIN rail.

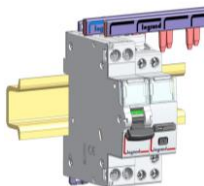

Module maintenance:

. It is possible to switch a Connected Dry-Contact in the middle of a row supplied with an upstream busbar without disconnecting the other devices on the same DIN rail.

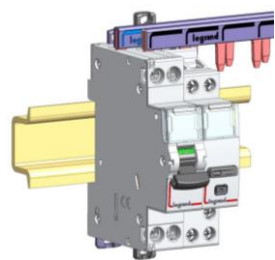

1. Unclip the clamps to put it in open position

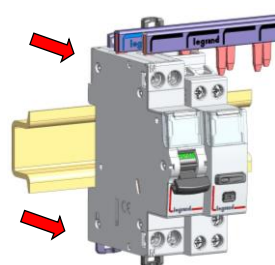

2. Pull the device forward in order to release it from the DIN rail

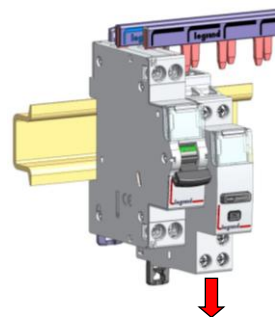

3. Pull the device downward in order to completely release it from the prongs of the busbar

4. PREPARATION - CONNECTION (continued)

Wiring of the upstream terminals:

Important: Activate the function peak OFF in the App

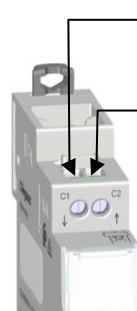

C1: IN terminal for control command (IN) ↓
Use a dry-contact. No power allowed.

C2: Out terminal self-protected Line for remote (OUT) ↑
Use a dry-contact. No power allowed.

Advantage: « auto protected terminals » technology. It is not necessary to put a 2A protection

In case of a remote control done via a wired push button, the control is done either via C1 and C2 terminals.

Warning: Do not wire a Neutral on C1 or C2

Authorized control wiring:

. Activate the specific function in the App.

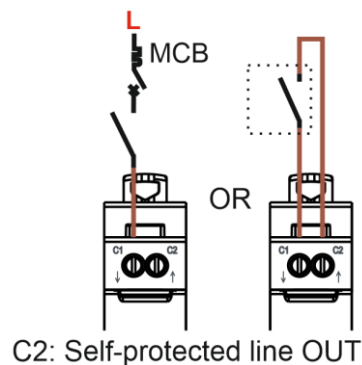

Wiring of the power supply and the Dry contact:

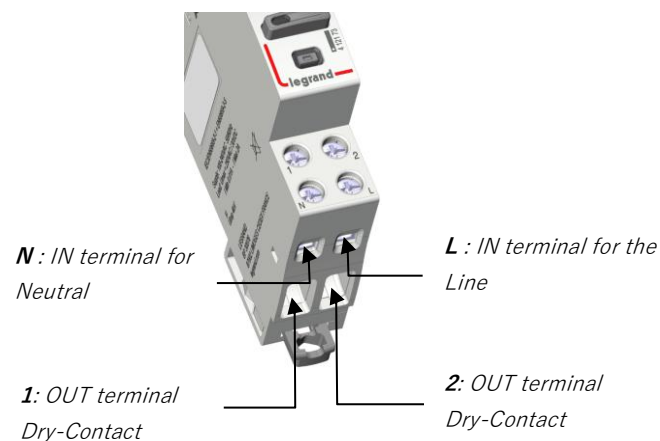

4. PREPARATION - CONNECTION *(continued)*

Commutable load by the Dry-Contact:

- . Maximum voltage: 250V AC or 30V DC
- . Maximum current: 2A
- . Minimum current: 0.01A

Wireless network:

- . Maximum number of devices connected to a zigbee gateway "with Netatmo" in the network: 100

Wiring diagrams:

- . Control of any type of device in single-phase from 12 to 30V DC via their terminal block provided for this purpose. eg : air conditioner, heating manager.
- For the protection of the installation, it is recommended to use a circuit breaker or a gG fuse with a rated current according to the cross section of the cables.

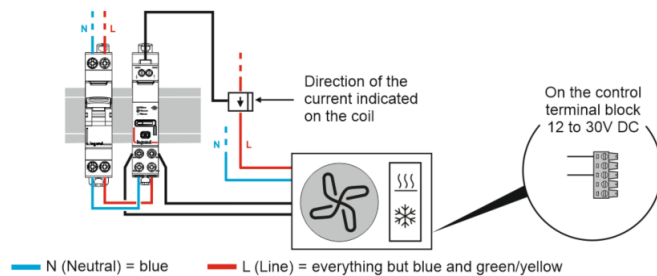

- . Control of a single-phase power contactor (eg: for the swimming pool pump).

To protect the connected Dry-Contact and the control circuit (terminals 1 and 2), it is mandatory to use a circuit breaker or a gG fuse with a nominal current of 2A.

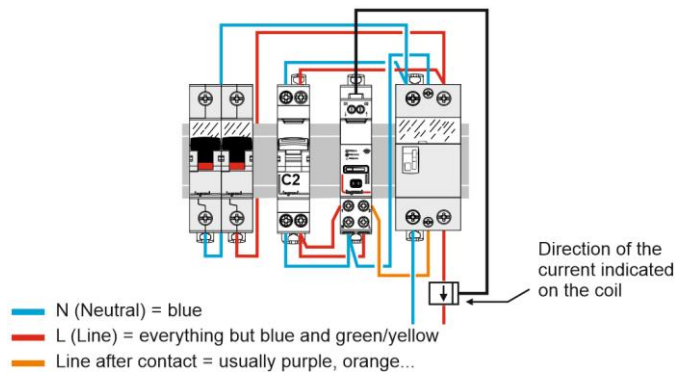

4. PREPARATION - CONNECTION *(continued)*

- . Management of charging station for electric vehicles (possibility of off-peak information).

For the protection of the installation, it is recommended to use a circuit breaker or a gG fuse with a rated current according to the cross section of the cables.

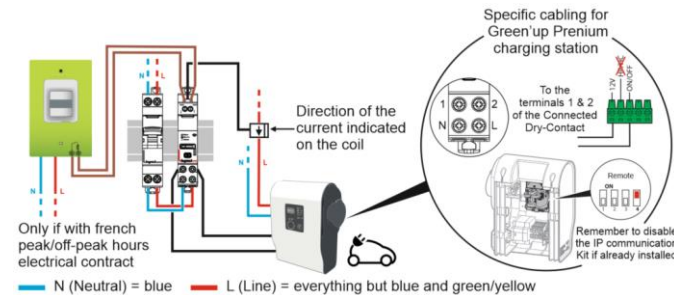

Recommended tools:

- . For the upstream terminals: Flat blade screwdriver 3.5 mm.
- . For the downstream terminals: Screwdriver Pozidriv n° 1 or flat-blade 4 mm.
- . For clamping: Screwdriver flat-blade (5,5mm or less) or Pozidriv n° 1

Upstream terminal connection (C1, C2):

- . Control screw terminals:
 - Terminal type: cage
 - Depth: 8 mm
 - Stripping length recommended: 8 mm
 - Screw head: slotted
 - Type of screw: M3
 - Minimum tightening torque: 0.3Nm / maxi: 0.5Nm / advised: 0.4Nm

Downstream terminal connection (N, L, 1, 2):

- . Power screw terminals:
 - Terminal type: cage
 - Depth: 9 mm
 - Stripping length recommended: 9 mm
 - Screw head: Posidriv n° 1 or slotted
 - Type of screw: M3,5
 - Minimum tightening torque: 0.8Nm / maxi: 1.4Nm / advised: 1Nm

Conductor type for remote control terminals (C1, C2):

- . Copper cables

	Without ferrule	With ferrule
Rigid cable	1x (0.75 à 1.5mm ²)	-
Flexible cable	1x (0.75 à 1.5mm ²)	1 x (0.75 à 1.5mm ²)

4. PREPARATION - CONNECTION *(continued)*

Conductor type for power terminals (N, L, 1, 2):

. Copper cables

	Without ferrule	With ferrule
Rigid cable	1x (0.75 à 2.5mm ²) 2 x (0.75 à 2.5mm ²)	-
Flexible cable	1x (0.75 à 2.5mm ²) 2 x (0.75 à 2.5mm ²)	1 x (0.75 à 2.5mm ²) 2 x (0.75 à 1.5mm ²)

Connection of the measurement coil:

Insert the measurement coil connector into the slot provided on the connected Dry-Contact until it locks (clips).



NB: If necessary, to disconnect it, use a small screwdriver on the clips.

Measurement coil capacity:

Conductor cross section	1.5mm ²	2.5mm ²	6mm ²	10mm ² to 25mm ²
Number of conductor flexible or rigid	8	5	3	1

Commands of the connected dry contact:

. Operation on-site, directly with the front face push-button of the device (I, auto, O).

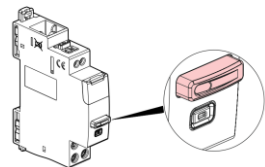

. Via smartphone with the Home + Control smartphone app.



Or

Connected Home ecosystems

. By voice through a vocal assistant.



. Possibility of associating a "with Netatmo" on-wall wireless connected push button (Maximum quantity: 20) via the Home + Control app.



4. PREPARATION - CONNECTION *(continued)*

Visualization of the operating mode of the device and contacts:

. Via the LED, on the push button command

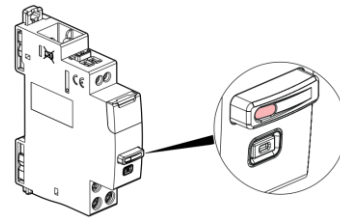

Color	Status	Meaning
	OFF	Manual mode and opened Contact (OFF)
	Slow blinking	Automatic mode and opened Contact (OFF)
	Slow blinking	Automatic mode and closed Contact (ON)
	Fixed	Manual mode and closed Contact (ON)

Visualization of the setup:

. Via the LED on the settings button

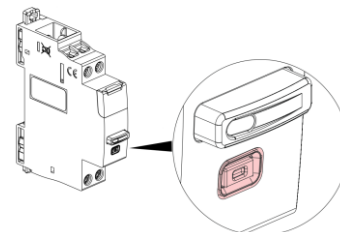

Color	Status	Meaning
	Fixed	Temporary status. Device not connected to the radio network
	Fixed	Temporary status. Device correctly paired to the radio network (when the radio network is still open)
	OFF	Normal status. Device paired to the radio network (when the radio network is closed)

4. PREPARATION - CONNECTION *(continued)*

Add a connected Dry-Contact in a connected installation (several steps):

. 1/ Beforehand, to create a connected installation you must install:

Either a Gateway module

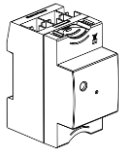

Or a connected starter pack (drawing of principle, works with any kind of "with Netatmo" connected starter pack).

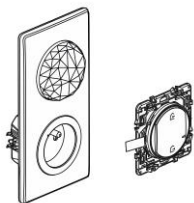

Or any kind of « with Netatmo » gateway

. 2/ Beforehand, the general circuit breaker must be turned OFF. Then after wiring step done, installation controlled, refit the front plate so that no active live part is accessible. Then the general circuit breaker can be powered back ON to simultaneously power devices and allow them to be connected to the network.

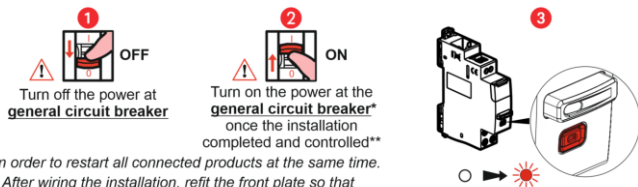

. 3/ Finalize the installation in the Legrand Home + Control smartphone app

Download the Home + Control App and follow the instructions for adding the connected product in your setup.

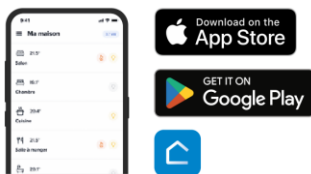

You also have the option of controlling your installation via a voice assistant and can customize your scenarios via the Home + Control App.



4. PREPARATION - CONNECTION *(continued)*

Connected Dry-Contact resetting to remove it from a connected installation:

. Press and hold over 5 seconds on the setting button until the LED on the setting button be fixed red. It is no longer paired with the Gateway module / Gateway power outlet.

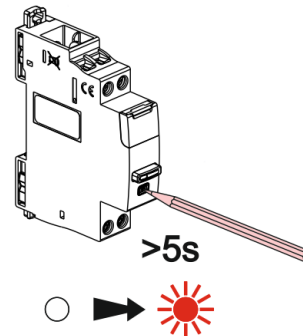

Other configurations & actions:

. All other features and settings such as scenarios etc... are directly explained step by step in the smartphone app.

Labelling:

. Circuit identification by way of a label inserted in the label holder situated on the front of the product.

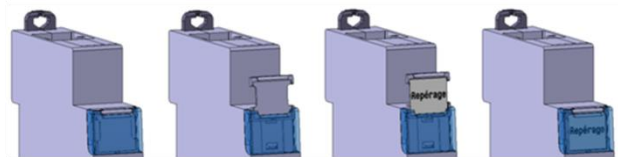

5. GENERAL CHARACTERISTICS

Marking of the Connected Dry-Contact:

Principle visuals:

Marking of the front side:

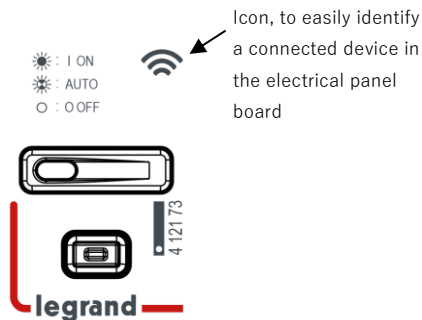

Sectioning distance:

. micro-gap construction contact according to the standard EN 60669-2-1

Rated insulation voltage (Ui):

. Ui = 250 V~

Degree of pollution:

. 2

Rated impulse withstand voltage (Uimp):

. 4 kV

Influence of altitude:

. No influence up to 2 000 m

Assigned frequency:

. 50 / 60 Hz

Rated operational Dry-Contact current:

. 2 A

Rated voltage of use (Ue):

. Ue = 100 to 240 V ~

Resistance to short-circuits:

. Presumed short circuit current 1500 A according to EN 60669-2-1
 . Thermal stress: 15 000 A²s according to EN 60669-2-1

Recommendations:

. For the Dry-Contact protection against short circuits according to the conditional current, it is recommended to use a circuit breaker or gG fuse with rated current ≤ 2 A.

Dry-Contact endurance:

. 20 000 000 operations without load
 . 40 000 operations under inductive load according to EN 60669-2-1
 . 10 000 operations under capacitive and inductive load according to EN 60669-2-1

Measuring coil characteristics:

Max current 80A

5. GENERAL CHARACTERISTICS (continued)

Characteristics of the radio interface:

. Standard IEEE 802.15.4
 . Frequencies 2,4 à 2,4835Ghz.
 . Transmitter output power <100mW.
 . Distance max between 2 radio devices: 50m in open field.

Dielectric resistance:

. 2000V between terminals and rail.
 . 750V between terminal 1 and 2 from Dry-Contact.
 . 3750V between SELV and LV.

Protection degree:

. Protection index of terminals against direct contacts: IP2X (wired device).
 . Protection index of the front face against direct contacts: IP3XD.
 . Class II, front panel with front plate.
 . Class of protection against mechanical impacts IK04.

Vibrations and shaking resistance:

. vibrations: 10 to 55 to 10Hz single amplitude 0.75mm.
 . Shaking: 1000m / s² (6 ± 1ms).

Plastic material:

. Self-extinguishing polycarbonate.
 . Heat and fire resistant according to IEC/EN 60669-2-1, glow-wire test at 960° C.
 . Classification UL 94 V0 (≥1.5mm).

Ambient operating temperature:

. Min. = - 5° C Max. = + 45° C.

Ambient storage temperature:

. Min. = - 40° C Max. = + 70° C.

Average weight:

. Dry-Contact: 66g.
 . Measurement coil: 41g.

Volume when packed:

. 0,62 dm³.

6. COMPLIANCE AND APPROVALS

Compliance to standards:

- . IEC/EN60669-2-1 + EN60669-2-5

Environment respect – Compliance with European Union Directives:

- . Compliance with Directive 2002/95/EC of 27/01/03 known as "RoHS" which provides for a restriction on the use of dangerous substances such as lead, mercury, cadmium, hexavalent chromium and polybrominated biphenyl (PBB) and polybrominated diphenyl ether (PBDE) brominated flame retardants from 1st July 2006
- . Compliance with the Directive 91/338/EEC of 18/06/91 and decree 94-647 of 27/07/04
- . Compliant with regulation REACH

Conformity with electromagnetic interference (EMC):

- . Compliant EN 301 489-1, IEC 60669-2-5, NF EN 60669-2-1

Immunity to shock waves

Radio transmission

Immunity to electrical transients in bursts.

Immunity to conducted disturbances induced by radio fields

Immunity to radiated fields

Electrostatic discharge immunity

Immunity to voltage dips and short break

- . Compliance radiated emission according to NF EN55032.

Plastic materials:

- . Halogen-free plastics.
- . Marking of parts according to ISO 11469 and ISO 1043.
- . ISO 7000: 2004, Graphical symbols to be used on equipment - Index and synopsis

Packaging:

- . Design and manufacture of packaging in accordance with Decree 98-638 of 20/07/98 and Directive 94/62 / EC.

7. AUXILIARIES AND ACCESSORIES

Beforehand, requires the installation of a " connected starter pack " or " a "gateway module".